

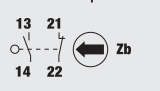
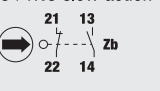
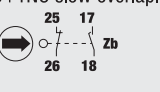
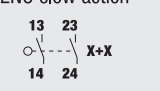
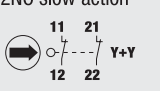
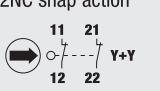
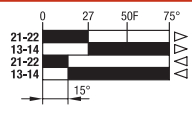
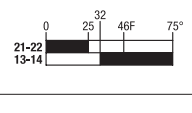
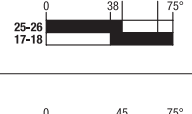
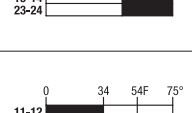
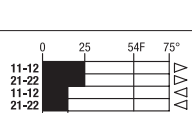
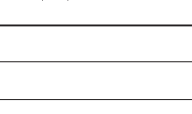

F

Thermoplastic roller variable length lever

| Contact element | |
|--|------------|
| 1NO+1NC snap action  | 00 |
| 1NO+1NC slow action  | 01 |
| 1NO+1NC slow overlap.  | 02 |
| 2NO slow action  | 03 |
| 2NC slow action  | 04 |
| 2NC snap action  | 05 |
| Weight | kg |
| Pack | pcs |
| H | mm |

| Cable entry | | | | | | | Contact travel |
|------------------------------|----------------------------|--------------------------|------------------------------|----------------------------|--------------------------|---|----------------|
| PG 13,5 | | | M20 x 1,5 | | | | |
| Plastic head Plastic body | Metal head Plastic body | Metal head Metal body | Plastic head Plastic body | Metal head Plastic body | Metal head Metal body | | |
| E10000FP | E10000FI | E10000FM | E10100FP | E10100FI | E10100FM |  | |
| E10001FP | E10001FI | E10001FM | E10101FP | E10101FI | E10101FM |  | |
| E10002FP | E10002FI | E10002FM | E10102FP | E10102FI | E10102FM |  | |
| E10003FP | E10003FI | E10003FM | E10103FP | E10103FI | E10103FM |  | |
| E10004FP | E10004FI | E10004FM | E10104FP | E10104FI | E10104FM |  | |
| E10005FP | E10005FI | E10005FM | E10105FP | E10105FI | E10105FM |  | |
| 0,099 | 0,15 | 0,24 | 0,079 | 0,13 | 0,225 | | |
| 1 | 1 | 1 | 1 | 1 | 1 | | |
| 116 ÷ 156 | 116 ÷ 156 | 113,5 ÷ 153,5 | 116 ÷ 156 | 116 ÷ 156 | 113,5 ÷ 153,5 | | |

 standard article

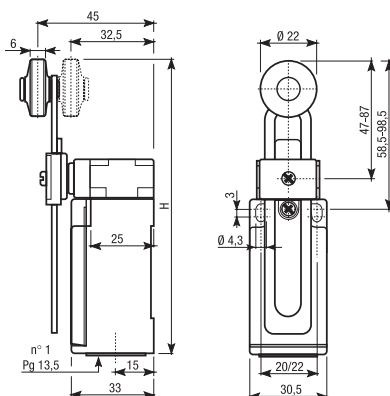

Drive cam operating parameters

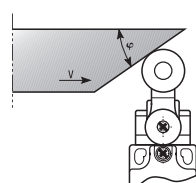

| φ | V max (m/s) |
|-----------|-------------|
| 30° | 1,5 |
| 45° | 1 |
| 60° | 0,75 |
| 60-90° | 0,25 |

Drive forces
 Minimum command force 15 Ncm
 Minimum forced opening force 35 Ncm