

440G-MT

Description

The 440G-MT solenoid switch is a positive mode, tongue operated guard locking interlock switch that locks a machine guard closed until power is isolated while the guard is open. The guard may only be opened when a signal is applied to the internal solenoid which releases the lock mechanism. The 440G-MT locking mechanism is designed to withstand forces up to 1600 N (360 lb) and the die-cast alloy housing is ideal for use in harsh environments.

The 440G-MT solenoid switch is designed for machines that do not stop immediately or where premature interruption of the machine could cause damage to tooling and components or cause an additional hazard.

A 24V DC enhanced version is available with diagnostic output, which may be used by a control system to indicate whether a guard door is open or shut independently of the lock mechanism status. A built in LED further visually indicates the status of the switch as “door open,” “door shut and unlocked,” and “door shut and locked.”

This enhanced version is supplied with a metal manual override key to more easily enable manual unlocking in conditions when power is not available to electrically unlock the switch.

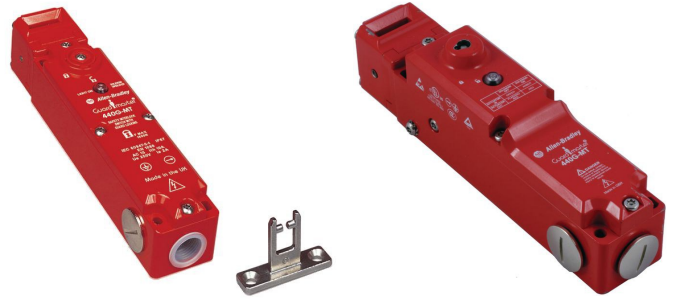

Features

- Mechanical lock
- High locking force—1600 N (360 lb)
- Heavy-duty die-cast alloy housing, ideal for harsh environments
- Diagnostic version available

Specifications

Safety Ratings						
Standards	EN954-1, ISO13849-1, IEC/EN60204-1, NFPA79, EN1088, ISO14119, IEC/ EN60947-5-1, ANSI B11.19, AS4024.1					
Safety Classification	Cat. 1 Device per EN954-1 May be suitable for use in Cat 3 or Cat 4 systems depending on the architecture and application characteristics					
Functional Safety Data (related to Safety Contacts) *	B10d: > 2 x 10 ⁶ operations at min. load PFH _D : < 3 x10 ⁻⁷ MTTFd: > 385 years May be suitable for use in performance levels Plc or Pld systems (according to ISO 13849-1:2006) and for use in SIL2 or SIL3 systems (according to IEC 62061) depending on the architecture and application characteristics					
Note: For up-to-date information, visit http://www.ab.com/Safety/						
Certifications	CE Marked for all applicable directives, cULus, TÜV, and CCC					
Outputs						
Safety Contacts ‡	3 N.C. or 2 N.C. direct opening action					
Auxiliary Contacts	1 N.O. or 2 N.O.					
Thermal Current I _{th}	10 A					
Rated Insulation Voltage	(Ui) 500V					
Switching Current @ Voltage, Min.	3 mA @ 18V DC					
Utilization Category						
A600/AC-15	(Ue)	600V	500V	240V	120V	
	(Ie)	1.2 A	1.4 A	3 A	6 A	
DC-13	(Ue)	24V				
	(Ie)	2 A				
Solenoid Characteristics						
Locking Type	Power to Release					
Holding Force, Max.	1600 N (360 lb)					
Power Supply	24V AC/DC or 110V AC or 230V AC					
Solenoid Power	13 W typical 100% ED					
Operating Characteristics						
Break Contact Force, Min.	6 N (1.35 lbf)					
Actuation Speed, Max.	160 mm (6.29 in.)/s					
Actuation Frequency, Max.	2 cycles/s					
Operating Radius, Min	60 mm (2.36 in.)					
Mechanical Life	1,000,000 operations					
Environmental						
Enclosure Type Rating	IP67					
Operating Temperature [C (F)]	-25...+60° (13...+140°)					
Physical Characteristics						
Housing Material	Painted zinc alloy					
Actuator Material	Stainless Steel					
Weight [g (lb)]	1400 (3.08)					
Color	Red					

* Usable for ISO 13849-1:2006 and IEC 62061. Data is based on the B10d value given and:

- Usage rate of 1op/10 mins., 24 hrs/day, 360 days/year, representing

51840 operations per year

- Mission time/Proof test interval of 38 years

‡ The safety contacts are described as normally closed (N.C.) i.e., with the guard closed, actuator in place (where relevant) and the machine able to be started.

Product Selection

Solenoid Voltage	Contact			Actuator Type	Cat. No.			
	Safety	Auxiliary	Action		M20 Conduit		Connector♣	
					M20	1/2 inch NPT	12-Pin M23	8-Pin Micro (M12)Δ
24V AC/DC	3 N.C.	1 N.O.	BBM	GD2 standard	440G-MT47037	440G-MT47039	440G-MT47041	440G-M3NBGDH-AC
				Fully flexible	440G-MT47038	440G-MT47040	440G-MT47042	440G-M3NBBDH-AC
				—	440G-MT47007	440G-MT47008	440G-MT47043	—
	2 N.C.	2 N.O.	BBM	GD2 standard	440G-MT47044	440G-MT47046	440G-MT47048	—
				Fully flexible	440G-MT47045	440G-MT47047	440G-MT47049	—
				—	440G-MT47010	440G-MT47011	440G-MT47050	—
24V DC with diagnostic function and metal override key	3 N.C.	1 N.O.	BBM	GD2 standard	440G-MT47149	440G-MT47150	440G-MT47151	—
				Fully flexible	440G-MT47152	440G-MT47153	440G-MT47154	—
				No actuator	440G-MT47155	440G-MT47156	440G-MT47157	—
	2 N.C.	2 N.O.	BBM	GD2 standard	440G-MT47158	440G-MT47159	440G-MT47160	—
				Fully flexible	440G-MT47161	440G-MT47162	440G-MT47163	—
				No actuator	440G-MT47164	440G-MT47165	440G-MT47166	—
110V AC/DC	3 N.C.	1 N.O.	BBM	GD2 standard	440G-MT47070	440G-MT47073	—	—
				Fully flexible	440G-MT47071	440G-MT47074	—	—
				—	440G-MT47013	440G-MT47009	—	—
	2 N.C.	2 N.O.	BBM	GD2 standard	440G-MT47077	440G-MT47079	—	—
				Fully flexible	440G-MT47078	440G-MT47080	—	—
				—	440G-MT47012	440G-MT47014	—	—
230V AC/DC	3 N.C.	1 N.O.	BBM	—	440G-MT47016	440G-MT47017	—	—
	2 N.C.	2 N.O.		—	440G-MT47015	440G-MT47024	—	—

♣ For connector ratings see Safety Switches and Connectors.

Δ With an 8-pin micro (M12) connector, not all contacts are connected. See Typical Wiring Diagrams for wiring details.

Recommended Logic Interfaces

Description	Safety Outputs	Auxiliary Outputs	Time Delay	Terminals	Reset Type	Power Supply	Cat. Page No.	Cat. No.
Single-Function Safety Relays								
MSR127RP	3 N.O.	1 N.C.	—	Removable (Screw)	Monitored Manual	24V AC/DC	MSR127RP/TP	440R-N23135
MSR127TP	3 N.O.	1 N.C.	—	Removable (Screw)	Auto./Manual	24V AC/DC	MSR127RP/TP	440R-N23132
MSR126T	2 N.O.	None	—	Fixed	Auto./Manual	24V AC/DC	MSR126R/T	440R-N23117
MSR30RT	2 N.O. Solid State	1 N.O. Solid State	—	Removable	Auto./Manual or Monitored Manual	24V DC	MSR30RT/RTP	440R-N23198
Specialty Safety Relays								
MSR178	3 N.O.	2 N.C.	0.5 s...30 min	Removable	Automatic	24V AC/DC, 115V AC or 230V AC	MSR178DP	440R-M23227
CU2	2 N.O.	1 N.C.	0.1 s...40 min	Fixed	—	24V AC/DC	CU2	440R-S07281
CU3	2 N.O.	1 N.C.	—	Fixed	Automatic/Manual	110V AC	CU3	440R-S35002
Modular Safety Relays								
MSR210P Base 2 N.C. only	2 N.O.	1 N.C. and 2 PNP Solid State	—	Removable	Auto./Manual or Monitored Manual	24V DC from the base unit	MSR210P	440R-H23176
MSR220P Input Module	—	—	—	Removable	—	24V DC	MSR220P	440R-H23178
MSR310P Base	MSR300 Series Output Modules	3 PNP Solid State	—	Removable	Auto./Manual Monitored Manual	24V DC	MSR310P	440R-W23219
MSR320P Input Module	—	2 PNP Solid State	—	Removable	—	24V DC from the base unit	MSR320P	440R-W23218

Note: For additional Safety Relays connectivity, see Safety Relays.

For additional Safety I/O and Safety PLC connectivity, see Programmable Safety Solutions.

For application and wiring diagrams, see Safety Applications and Wiring Diagrams.

Connection Systems

Description	8-Pin Micro	12-Pin M23
Cordset	889D-F8AB-*	889M-F12AH-*
Patchcord	889D-F8ABDM-‡	889M-F12AHMU-§









* Replace symbol with 2 (2 m), 5 (5 m), or 10 (10 m) for standard cable lengths.

‡ Replace symbol with 1 (1 m), 2 (2 m), 3 (3 m), 5 (5 m), or 10 (10 m) for standard cable lengths.

§ Replace symbol with 0M3, (0.3 m), 0M6 (0.6 m), 1 (1 m), 2 (2 m) or 3 (3 m) for standard lengths.

Note: For additional information, see Safety Connection Systems.

Accessories

Description	Dimensions	Cat. No.
 GD2 standard actuator	Actuators*	440G-A27011
 GD2 flat actuator		440K-A11112
 Fully flexible actuator		440G-A27143
 Sliding bolt actuator		440G-A27163
 Extended flat actuator		440K-A17116
 Replacement Cover, No LED, No Override Key	—	440G-MT47120
 Replacement Cover, LED, Override Key	—	440G-MT47123
 Emergency override key (See Warning below.)	—	440G-A36026
 Dust Cover	—	440K-A17180



WARNING: Do not attach the Emergency Override Key to the 440G-MT switch.

Approximate Dimensions

Dimensions are shown in mm (in.). Dimensions are not intended to be used for installation purposes.

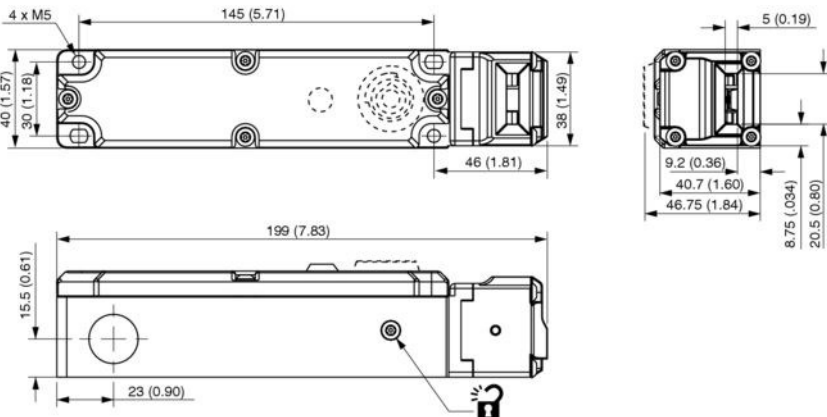

Note: 2D, 3D and electrical drawings are available on www.ab.com.

Typical Wiring Diagrams

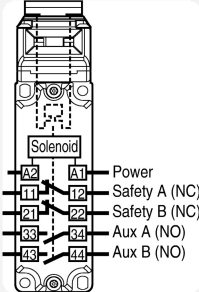
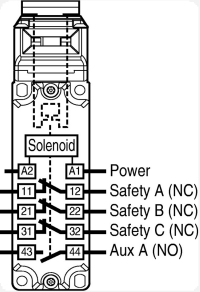
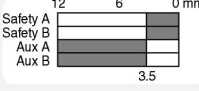
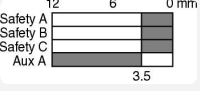
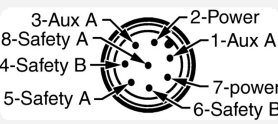
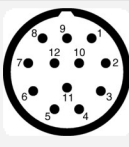
		2 N.C. & 2 N.O.	3 N.C. & 1 N.O.
Contact Configuration			
Contact Action			
<input type="checkbox"/> Open <input checked="" type="checkbox"/> Closed		BBM	BBM
8-Pin Micro (M12)		–	
12-Pin M23 QD	1 and 3	Solenoid Power	Solenoid Power
	4 and 6	Safety A	Safety A
	7 and 8	Safety B	Safety B
	2 and 5	Aux A	Safety C
	9 and 10	Aux B	Aux A
	Pin 11 not connected.	12	Ground
8-Pin Cordset 889D-F8AB-*	Brown Blue	–	Solenoid Power
	Grey Red	–	Safety A
	Yellow Pink	–	Safety B
	White Green	–	Aux A
12-Pin Cordset 889M-F12AH-*	Brown Grey	Solenoid Power	Solenoid Power
	Pink Yellow	Safety A	Safety A
	White Red/Blue	Safety B	Safety B
	Blue Red	Aux A	Safety C
	Black Violet	Aux B	Aux A
Grey/Pink not connected.	Green	Ground	Ground

* Replace symbol with 2 (2 m), 5 (5 m) or 10 (10 m) for standard cable lengths.

Diagnostic Version

Actuator	LED Output Matrix	
	Solenoid Off	Solenoid On
In	Green	Amber
Out	Flashing Red	Red

Diagnostic Electrical Output

Actuator	Voltage
In	0V DC
Out	+24V DC

Electrical output independent of solenoid status. Maximum output is 100 mA.

