

Safety Switches
Non-Contact Switches
 Magnetically Coded

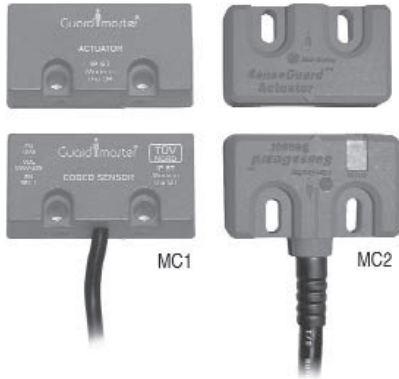

Description

With the increasing speed and complexity of applications a simple magnetic switch may be insufficient to meet the increased risks, therefore the design incorporates several magnetically sensitive elements which must be triggered in a particular sequence to operate correctly.

The sensor with its molded-in brackets and diminutive size, is extremely versatile and simple to install. For high-risk applications the control unit is used with a single sensor to give a high-integrity system. For other applications, multiple sensors (including mechanical switches) can be connected.

Features

- Noncontact actuation
- Magnetic coded sensing
- High tolerance to misalignment
- Designed for use with specified controllers

Specifications

	MC1	MC2
Safety Ratings		
Standards	EN954-1, ISO13849-1, IEC/EN60204-1, NFPA79, EN1088, ISO14119, IEC60947-5-1, IEC/EN60947-5-3, ANSI B11.19, AS4024.1	
Safety Classification	Cat. 1 device per EN 954-1 dual channel contacts suitable for Cat. 3 or 4 systems	
Functional Safety Data	B10d = > 2 x 10 ⁶ operations at min. PFH _D = > 3 x 10 ⁷ MTTFd = > 385 years Dual channel interlock may be suitable for Performance levels PLe or PLd (according to ISO 13849-1:2006) and for use in SIL2 or SIL3 systems (according to IEC 62061) depending on application characteristics	
Certifications	CE marked for all applicable directives, cULus, and TÜV	
Outputs (Guard Door Closed, Actuator in Place)		
Safety Outputs	2 N.C. REEDS	2 N.C. Solid-State Relays
Auxiliary Outputs	—	1 PNP, 0.2 A max. Status Off (0V DC)
Operating Characteristics		
Operating Distance, Make—mm (in)	8 (0.3)	10 (0.39)
Operating Distance, Break—mm (in)	15 (0.59)	25 (0.98)
Misalignment Tolerance, Min	See Misalignment Wire	
Repeat Accuracy	10% of Sensing Range	
Output Current, Max.	200 mA	200 mA
Switching Current @ Voltage, Max.	24V DC @ 200 mA	24V DC @ 200 mA +10%/-15%
Operating Voltage/Power Supply	—	24V DC, +10%/-15%/50 mA max./Class 2 SELV
Frequency of Operating Cycle	1 Hz	1 Hz
Environmental		
Enclosure Type Rating	IP 67 (NEMA 6P)	IP 69K
Operating Temperature—C (F)	-10...+55° (+14...+131°)	
Relative Humidity	5...95%	
Shock	IEC 68-2, 27, 30 g, 11 ms	
Vibration	IEC 68-2-6, 10...55 Hz	
Radio Frequency	IEC 61000-4-3, IEC 61000-4-6	
Physical Characteristics		
Housing Material	Molded ABS	Ultrador
Actuator Material	Molded ABS	Ultrador
Color	Red	

* Usable for ISO 13849-1:2006 and IEC 62061. Data other than B10d is based on:
 - Usage rate of 1op/10 mins., 24 hrs/day, 360 days/year, representing 51840 operations per year
 - Mission time/Proof test interval of 38 years
 * The safety contacts are described as normally closed (N.C.) i.e., with the guard closed, actuator in place (where relevant) and the machine able to be started.

Product Selection

Type	Operating Voltage/Input Current	Safety Outputs	Auxiliary Outputs	LED Indicator	Connection	Cat. No.
MC1	—	2 N.C. REEDS	—	No	6 in Pigtail, 4-Pin Micro (M12)	440N-Z2NRS1C
					3 m Cable	440N-Z2NRS1A
					10 m Cable	440N-Z2NRS1B
MC2	24V DC, +10%/-15%/50 mA max.	2 N.C. Solid-State Relays	1 PNP, 0.2 A max. Status Off (0V DC)	Yes	6 in Pigtail, 8-Pin Micro (M12)	440N-Z21W1PH
					3 m Cable	440N-Z21W1PA
					10 m Cable	440N-Z21W1PB

Recommended Logic Interfaces

Description	Safety Outputs	Auxiliary Outputs	Terminals	Reset Type	Power Supply	Cat. Page No.	Cat. No.
Single-Function Safety Relays for 2 N.C. Contact Switch							
MSR127RP	3 N.O.	1 N.C.	Removable (Screw)	Monitored Manual	24V AC/DC	5-24	440R-N23135
MSR127TP	3 N.O.	1 N.C.	Removable (Screw)	Auto./Manual	24V AC/DC	5-24	440R-N23132
Modular Safety Relays							
MSR210P Base 2 N.C. only	2 N.O.	1 N.C. and 2 PNP Solid-State	Removable	Auto./Manual or Monitored Manual	24V DC from the base unit	5-74	440R-H23176
MSR220P Input Module	—	—	Removable	—	24V DC	5-78	440R-H23178
MSR310P Base	MSR300 Series Output Modules	3 PNP Solid State	Removable	Auto./Manual Monitored Manual	24V DC	5-94	440R-W23219
MSR320P Input Module	—	2 PNP Solid State	Removable	—	24V DC from the base unit	5-98	440R-W23218

Note: For additional Safety Relays connectivity, see the Logic section of this catalog.
For additional Safety I/O connectivity, see the Safety I/O section of this catalog.
For Application and wiring diagrams, see the Applications section of this catalog.

Connection Systems

Description	Connection to Distribution Box 4-Pin Micro (M12)	8-Pin Micro (M12)
	2 N.C.	2 N.C. & 1 N.O.
Cordset	889D-F4AC-*	889D-F8AB-*
Patchcord	889D-F4ACDM-*	889D-F8ABDM-*
Distribution Box	898D-4LT-DM4	—
Shorting Plug	898D-41LU-DM	—
T-Port	898D-43LY-D4	—

* Replace symbol with 2 (2 m), 5 (5 m), or 10 (10 m) for standard cable lengths.
* Replace symbol with 1 (1 m), 2 (2 m), 3 (3 m), 5 (5 m), or 10 (10 m) for standard cable lengths.
Note: For additional information, see the Safety Connection System section of this catalog.

Accessories

Description	Cat. No.
MC1 Spare Actuator	440N-A17233
MC2 Spare Actuator	440N-A32114

3-Interlock Switches

Safety Switches
Non-Contact Switches
 Magnetically Coded

Approximate Dimensions—mm (inches)

Dimensions are not intended to be used for installation purposes.

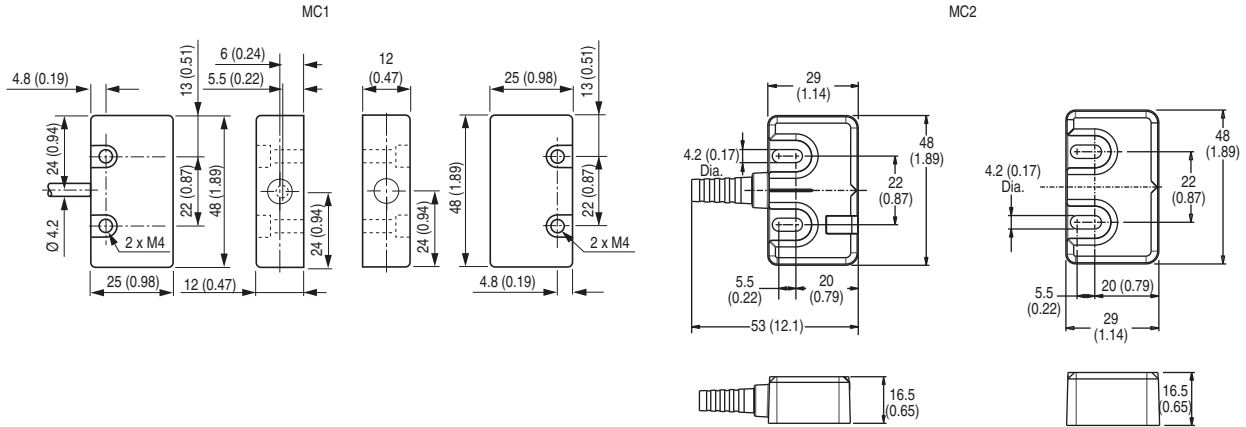

Typical Wiring Diagrams

Description		MC1	MC2
		2 N.C.	2 N.C. + 1 N.O.
4-Pin Micro (M12)			—
8-Pin Micro (M12)		—	
Cordset 889D-F4AC- or Cable Version	Brown	Safety A	—
	Blue		
	White	Safety B	—
	Black		
8-Pin Cordset 889D-F8AB- or Cable Version	Grey		Safety A
	Red		Safety A
	Pink		Safety B
	Yellow		Safety B
	White		Aux
	Brown		24V DC +
	Blue		Gnd
	Green		NA

* Replace symbol with 2 (2 m), 5 (5 m) or 10 (10 m) for standard cable lengths.

Sensing & Misalignment Curve

MC1

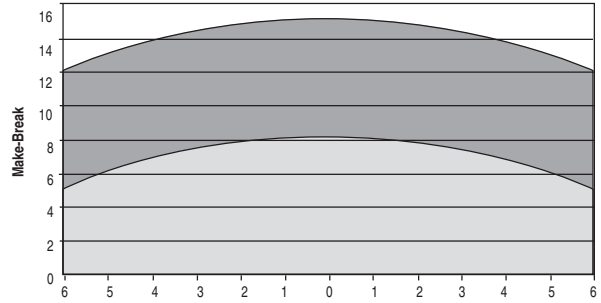
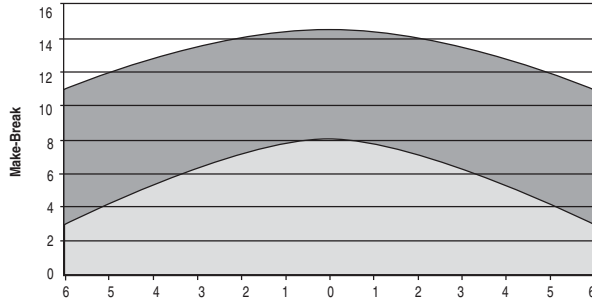
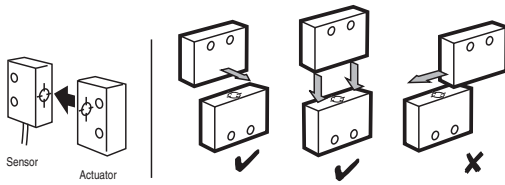

MC2

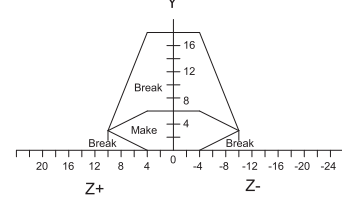
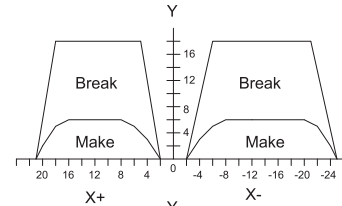
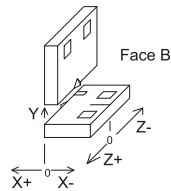
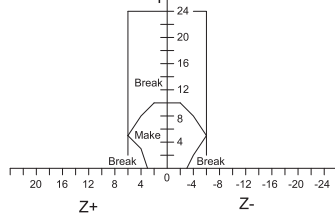
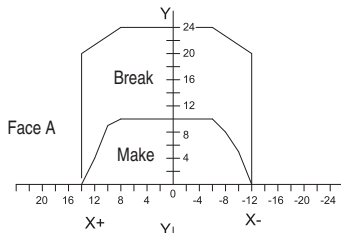
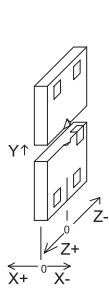

MC2 Application Wiring Example

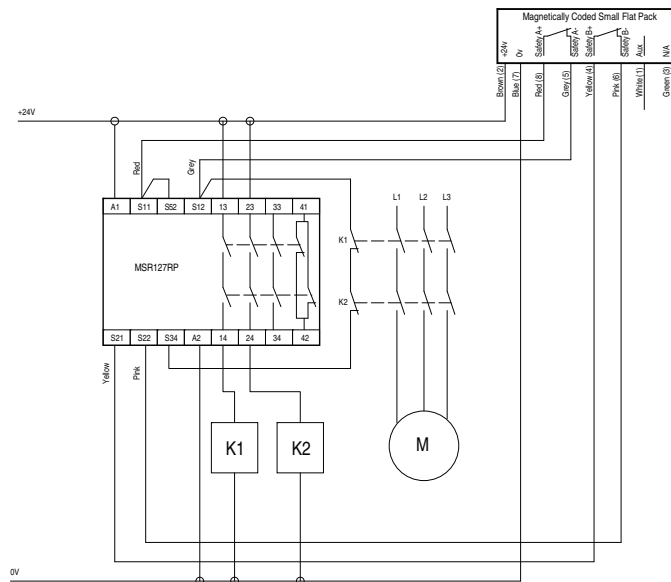

3-Interlock Switches