

## The Best Relation



## D2n Relay



108-98007  
Rev. C  
EC-JM00-0009-03  
ECOC: JM10  
1. Apr. 04

2 pole telecom relay, non-polarized,  
Through Hole Type (THT)

Relay types: non-latching with 1 coil

#### Features

- Standard DIL relay
- Dimensions 20.3 x 10.1 x 10.43 mm, 0.800 x 0.400 x 0.450 inch
- Switching and continuous current 3 A
- 2 changeover contacts (2 form C / DPDT)
- Single contacts
- Immersion cleanable
- Four different coil sensitivities  
(150, 200, 400, > 500 mW)
- Surge voltage resistance meets FCC Part 68 requirement:  
1.5 kV (10 / 160  $\mu$ sec) between coil and contacts



#### Typical applications

- Communications equipment
- Office equipment
- Measurement and control equipment
- Entertainment electronics
- Medical Equipment
- Consumer electronics

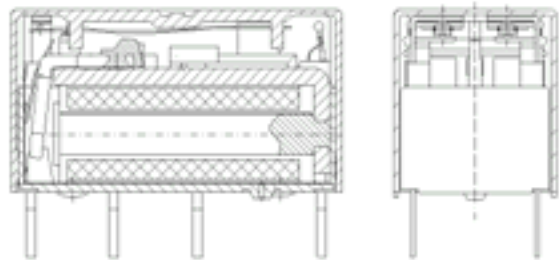

UL 508 File No. E 111441

#### European Directive conformance:

D2n relay product conformance according to:

- Directive 2000/53/EC: ELV (End of Life of Vehicles)
- Directive 2002/95/EC: ROHS (Restrictions of the use of certain hazardous substances in electrical and electronic equipment)

Compliance is evidenced by written declaration from all raw material suppliers.

Tyco Electronics AXICOM only has responsibility for the proper processing of these materials.

Confirmation is valid for date codes  $\geq$  0418

THT Version

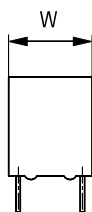
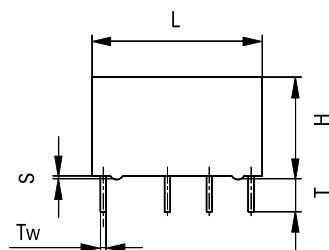

Dimensions

	THT	
	mm	inch
L	20.2 ± 0.1	0.795 ± 0.004
W	10.0 ± 0.1	0.394 ± 0.004
H	11.43 ± 0.2	0.450 - 0.008
T	3.5 ± 0.3	0.138 ± 0.012
Tw	0.72 - 0.2	0.028 - 0.008
S	0.3 ± 0.1	0.012 ± 0.004

Mounting hole layout

View onto the component side of the PCB  
(top view)

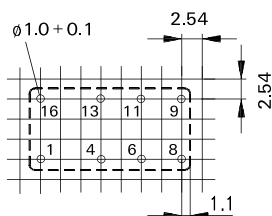

Basic grid 2.54 mm

Terminal assignment

Relay - top view

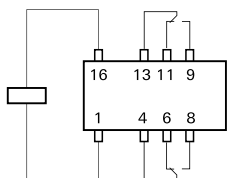

## Coil Data (values at 23 °C)

## Ordering Information

Nominal voltage $U_{nom}$	Operate/set voltage range		Release/ reset voltage Minimum	Coil power	Coil Resistance	Relay code	Tyco part number
	Minimum voltage $U_{min}$	Maximum voltage $U_{max}$					
Vdc	Vdc	Vdc	Vdc	mW	$\Omega / \pm 10\%$		

## 150 mW nominal power consumption

5	4.0	11.7	0.25	150	167	V23105A5001A201	8-1393792-5
6	4.8	14.0	0.30	150	240	V23105A5002A201	8-1393792-7
9	7.2	21.0	0.45	150	540	V23105A5006A201	9-1393792-1
12	9.6	28.0	0.60	150	960	V23105A5003A201	8-1393792-8
24	19.2	56.0	1.20	165	3480	V23105A5005A201	9-1393792-0

## 200 mW nominal power consumption

3	2.1	6.1	0.15	200	45	V23105A5308A201	0-1393793-5
5	3.5	10.1	0.25	200	125	V23105A5301A201	9-1393792-3
6	4.2	12.2	0.30	200	180	V23105A5302A201	9-1393792-5
9	6.3	18.2	0.45	200	405	V23105A5306A201	0-1393793-2
12	8.4	24.3	0.60	200	720	V23105A5303A201	9-1393792-7
24	16.8	48.6	1.20	200	2880	V23105A5305A201	9-1393792-9
48	33.6	97.2	2.40	200	11520	V23105A5307A201	0-1393793-3

## 400 mW nominal power consumption

5	3.5	7.2	0.25	400	62	V23105A5401A201	0-1393793-6
6	4.2	8.6	0.30	400	90	V23105A5402A201	0-1393793-7
9	6.3	12.9	0.45	400	203	V23105A5406A201	1-1393793-0
12	8.4	17.2	0.60	400	360	V23105A5403A201	0-1393793-8
24	16.8	34.3	1.20	400	1440	V23105A5405A201	0-1393793-9
48	33.6	68.6	2.40	400	5760	V23105A5407A201	1-1393793-1

## &gt; 500 mW nominal power consumption

5	3.5	6.1	0.25	695	36	V23105A5501A201	1-1393793-6
6	4.2	7.3	0.30	515	70	V23105A5502A201	1-1393793-8
9	6.3	10.9	0.45	580	140	V23105A5506A201	2-1393793-3
12	8.4	14.5	0.60	515	280	V23105A5503A201	1-1393793-9
24	16.8	29.1	1.20	550	1050	V23105A5505A201	2-1393793-1
48	33.6	58.1	2.40	575	4000	V23105A5507A201	2-1393793-4

## Coil versions, BT 47 type / specification T4563 C (current tested)

Nominal voltage	Operating current	Nominal power consumption	Resistance	British Telecom Code	Relay code	Tyco Part Number
Vdc	mA	mW	$\Omega / \pm 10\%$			
5	80	695	36	47 W / 5	V23105A5475A201	1-1393793-2
10	32.5	500	200	47 W / 9	V23105A5479A201	3-1393794-0
12	27	515	280	47 W / 6	V23105A5476A201	1-1393793-3
24	14	550	1050	47 W / 7	V23105A5477A201	1-1393793-4
48	7	575	4000	47 W / 8	V23105A5478A201	1-1393793-5

**Coil operating range**

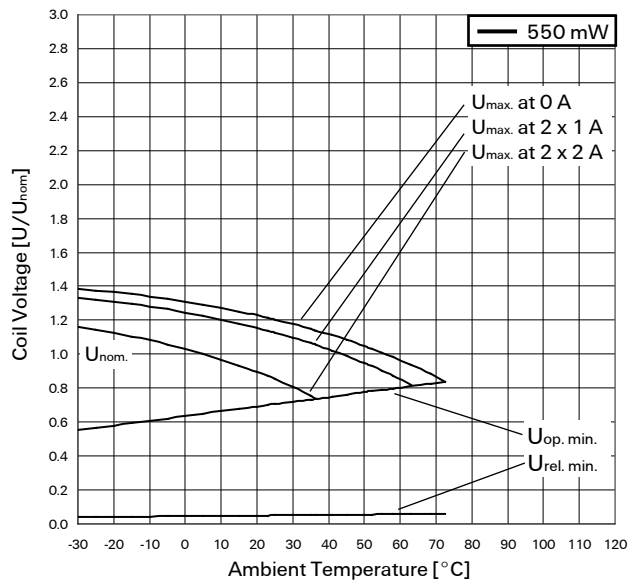
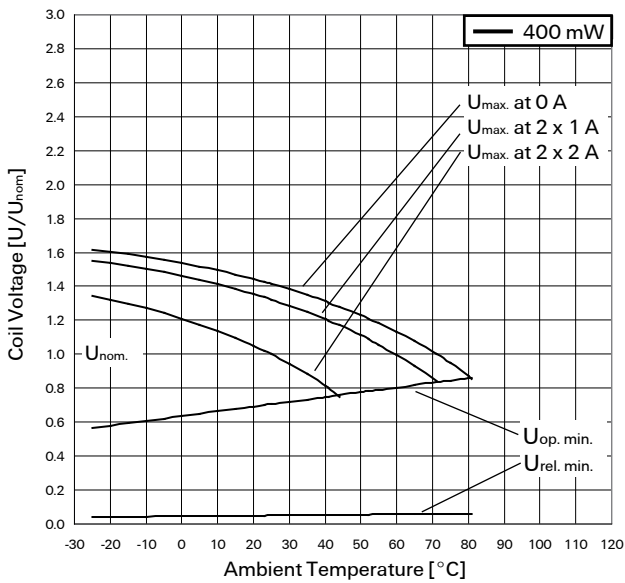
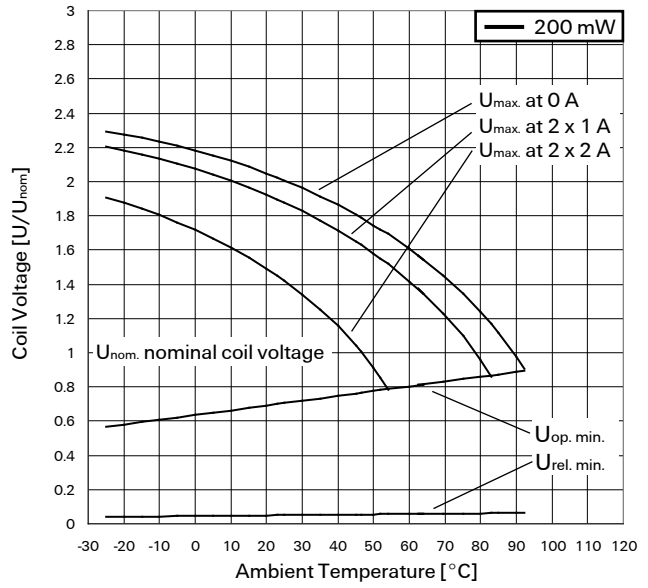
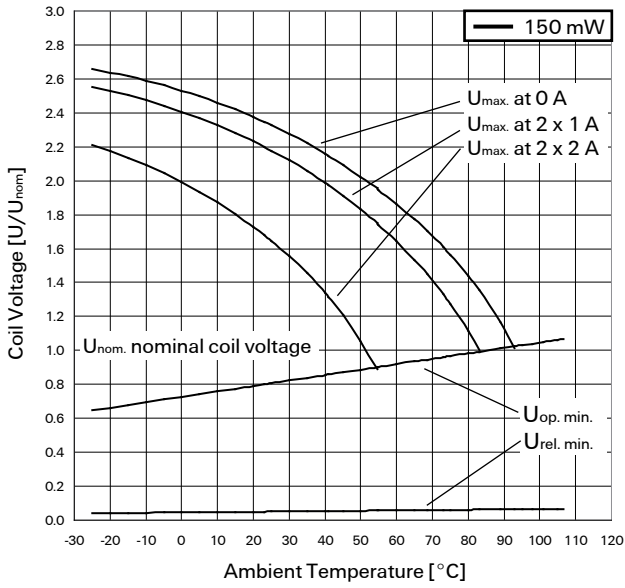

U<sub>nom</sub> = Nominal coil voltage

U<sub>max.</sub> = Upper limit of the operative range of the coil voltage (limiting voltage) when coils are continuously energized

U<sub>op. min.</sub> = Lower limit of the operative range of the coil voltage (reliable operate voltage)

U<sub>rel. min.</sub> = Lower limit of the operative range of the coil voltage (reliable release voltage)

**Ordering Code**

V 2 3 1 0 5 - A 5 - A 2 0 1

D2n Relay Identification

Version

- 0 = 150 mW nominal power consumption
- 3 = 200 mW
- 4 = 400 mW
- 5 = 550 mW

Coil number

- 08 = 3 V nominal voltage (only with 150/200 mW nominal coil power consumption\*)
- 01 = 5 V nominal voltage
- 02 = 6 V
- 06 = 9 V
- 04 = 10 V (only with 500 mW nominal coil power consumption)
- 03 = 12 V
- 05 = 24 V
- 07 = 48 V (not with 150 mW nominal coil power consumption)

BT 47 versions

- 475 = 5 V nominal voltage
- 479 = 10 V
- 476 = 12 V
- 477 = 24 V
- 478 = 48 V

Contact assembly

A201 = 2 changeover contacts; silver nickel, gold-plated, against silver nickel, gold-plated

\*) Coils with 400/500 mW nominal power consumption on request

Ordering example: V23105-A5301-A201

D2n Relay, coil 5 V nominal voltage, 200 mW nominal power consumption,  
Contact material silver nickel, gold-plated, against silver nickel, gold plated

**Contact Data**

Number of contacts and type	2 changeover contacts
Contact assembly	single contacts
Contact material	Silver-nickel, gold-covered
Limiting continuous current at max. ambient temperature	3 A
Maximum switching current	3 A
Maximum swichting voltage	220 Vdc 250 Vac
Maximum switching capacity	60 W, 125 VA
Thermoelectric potential	> 10 $\mu$ V
Minimum switching voltage	100 $\mu$ V
Initial contact resistance / measuring condition: 10 mA / 20 mV	< 100 m $\Omega$
Electrical endurance at 230 Vac / 0.5 A	typ. 3.0 x 10 <sup>5</sup> operations
at 6 Vdc / 0.1 A	typ. 2.0 x 10 <sup>6</sup> operations
at 30 Vdc / 1 A	typ. 5.0 x 10 <sup>5</sup> operations
at 30 Vdc / 2 A	typ. 1.0 x 10 <sup>5</sup> operations
Mechanical endurance	typ. 15.0 x 10 <sup>6</sup> operations
UL contact ratings	30 Vdc / 1.0 A 100 Vdc / 0.3 A 125 Vac / 0.5 A for 150 mW and 200 mW coil 125 Vac / 1.0 A for 400 mW and 500 mW coil

**Max. DC load breaking capacity**

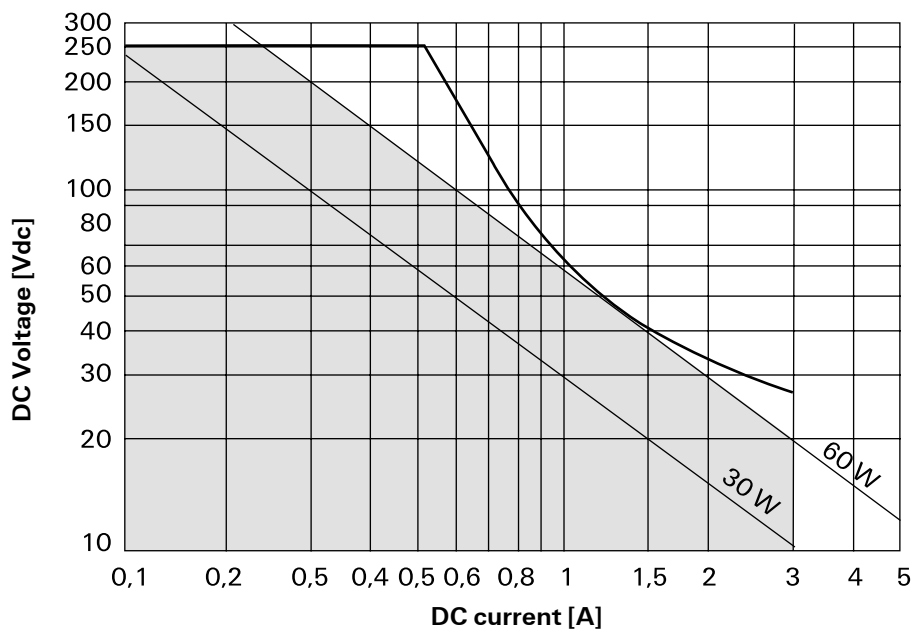

**Insulation**

Insulation resistance at 500 Vdc	> 10 <sup>9</sup> Ω
Dielectric test voltage (1 min)	
between coil and contacts	1000 Vrms
between adjacent contact sets	750 Vrms
between open contacts	750 Vrms
Surge voltage resistance	
according to FCC 68 (10 / 160 μs)	
between coil and contacts	1500 V
between adjacent contact sets	1500 V
between open contacts	1500 V

**High Frequency Data**

Capacitance	
between coil and contacts	max. 2 pF
between adjacent contact sets	max. 1.5 pF
between open contacts	max. 1 pF
RF Characteristics	
Isolation at 100 / 900 MHz	-39.0 dB / -20.7 dB
Insertion loss at 100 / 900 MHz	-0.02 dB / -0.27 dB
V.S.W.R. at 100 / 900 MHz	1.04 / 1.40

**General data**

Operate time at $U_{nom}$ typ. / max.	5 ms / 7 ms
Release time without diode in parallel, typ. / max.	4 ms / 6 ms
Release time with diode in parallel, typ. / max.	7 ms / 10 ms
Bounce time at closing contact, typ. / max.	3 ms / 5 ms
Maximum switching rate without load	20 operations/s
Ambient temperature	
150 and 200 mW coil	-25° C ... +85° C
400 mW coil	-25° C ... +75° C
500 mW coil	-25° C ... +60° C
Thermal resistance	< 100 K/W
Maximum permissible coil temperature	105° C
Vibration resistance (function)	10 g
	10 to 55 Hz
Shock resistance, half sinus, 11 ms	10 g (function)
	40 g (damage)
Degree of protection / Environmental protection	immersion cleanable, IP 67 / RT III
Needle flame test	application time 20 s, burning time < 15 s
Mounting position	any
Processing information	Ultrasonic cleaning is not recommended
Weight (mass)	max. 2.5 g
Terminal coating	SnCu 0,7
Resistance to soldering heat	260° C / 10 s

All data refers to 23° C unless otherwise specified.



Packing

Dimensions in mm

Tube for THT version - 25 relays per tube, 1000 relays per box

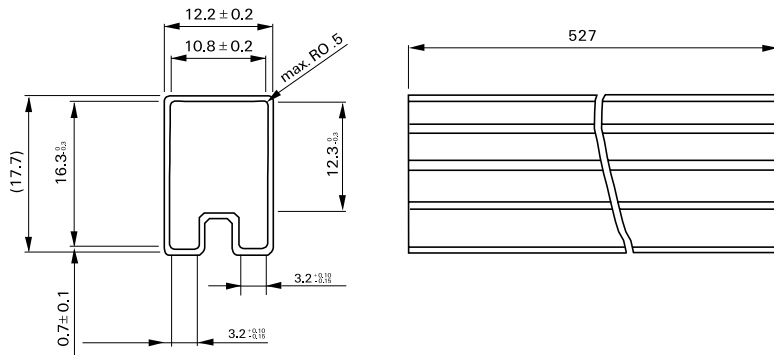

## IM Relays

4<sup>th</sup> generation slim line – low profile polarized 2 c/o telecom relay with bifurcated contacts, available as non latching or latching relay with 1 coil. Nominal voltage range from 1.5... 24 V, coil power consumption of 140... 200 mW, latching relays with 1 coil 100 mW. The IM relay is available as through hole and surface mount type (J-Legs and Gull Wings) and capable to switch loads up to 60 W/62,5 VA. Dielectric strength fulfills the Bellcore requirements according GR 1089 (2,5 kV – 2 / 10  $\mu$ s) and FCC part 68 (1,5 kV – 10 / 160  $\mu$ s). The IM relay is CECC/IECQ approved and certified in accordance with IEC/EN 60950 and UL 1950. Dimensions approx. 10 x 6 mm board space and 5,65 mm height.

## P2 Relays

3<sup>rd</sup> generation polarized 2 c/o telecom relay with bifurcated contacts, available as non latching or latching relay with 1 or 2 coils. Nominal voltage range from 3 ... 24 V, coil power consumption 140 mW, latching relays with 1 coil 70 mW. The P2 Relay is available as through hole or surface mount type and capable to switch currents up to 5 A. Dielectric strength fulfills the Bellcore requirements according GR 1089 (2,5 kV – 2 / 10  $\mu$ s) and FCC part 68 (1,5 kV – 10 / 160  $\mu$ s). Dimensions approx. 15 x 7,5 mm board space and 10 mm height.

## FX Relays

3<sup>rd</sup> generation polarized 2 c/o telecom relay with bifurcated contacts, available as non latching or latching relay with 1 coil. Nominal voltage range from 3 ... 48 V, coil power consumption of 80 ... 260 mW for the high sensitive version, 140... 300 mW for the standard version, latching relays with 1 coil 100 mW. The FX2 relay is available as through hole type and capable to switch loads up to 60 W/62,5 VA. Dielectric strength fulfills the Bellcore requirements according GR 1089 (2,5 kV – 2 / 10  $\mu$ s) and FCC part 68 (1,5 kV – 10 / 160  $\mu$ s). The FX2 is CECC/IECQ approved and certified in accordance with IEC/EN 60950 and UL 1950. Dimensions approx. 15 x 7,5 mm board space and 10,7 mm height.

## FT2 / FU2 Relays

3<sup>rd</sup> generation non polarized, non latching 2 c/o telecom relay with bifurcated contacts. Nominal voltage range from 3 ... 48 V, coil power consumption 200 ... 300 mW. Most sensitive 48 V relay. Available as through hole and surface mount type. Dielectric strength fulfills the Bellcore requirements according GR 1089 (2,5 kV – 2 / 10  $\mu$ s) and FCC part 68 (1,5 kV – 10 / 160  $\mu$ s). The FT2/FU2 is CECC/IECQ approved and certified in accordance with IEC/EN 60950 and UL 1950. Dimensions approx. 15 x 7,5 mm board space and 10 mm height.

## FP2 Relays

3<sup>rd</sup> generation polarized 2 c/o telecom relay with bifurcated contacts, available as non latching or latching relay with 1 or 2 coils. Nominal voltage range from 3 ... 48 V, coil power consumption of 80 ... 260 mW for the high sensitive version, 140... 300 mW for the standard version, latching relays with 1 coil 100 mW. The FP2 Relay is available as through hole type and capable to switch loads up to 30 W/62,5 VA. Dielectric strength fulfills FCC part 68 (1,5 kV – 10 / 160  $\mu$ s). The FP2 is CECC/IECQ approved. Dimensions approx. 14 x 9 mm board space and 5 mm height.

## MT2 / MT4

2<sup>nd</sup> generation non polarized, non latching 2 c/o and 4 c/o telecom and signal relay with bifurcated contacts. Nominal voltage range from 4.5 ... 48 V, coil power consumption 150/200/300/400 and 550 mW, and 300 mW (MT4). Dielectric strength fulfills the requirements according FCC part 68 (1,5 kV – 10 / 160  $\mu$ s) for both and the Bellcore requirements according GR 1089 (2,5 kV – 2 / 10  $\mu$ s) the MT4 only. Dimensions MT2 approx. 20 x 10 mm board space and 11 mm height, MT4 approx. 20 x 15 mm board space and 11 mm height.

## D2n Relays

2<sup>nd</sup> generation non polarized 2 c/o relay for telecom and various other applications. Nominal voltage range from 3 ... 48 V, coil power consumption from 150 ... 500 mW. The D2n relay is capable to switch currents up to 3 A. Dielectric strength fulfills the requirements according FCC part 68 (1,5 kV – 10 / 160  $\mu$ s). Dimensions approx. 20 x 10 mm board space and 11,5 mm height.

## P1 Relays

Extremely sensitive, polarized 1 c/o relay with bifurcated contacts for a wide range of applications, available as non latching or latching relay with 1 or 2 coils. Nominal voltage range from 3 ... 24 V, coil power consumption 65 mW, latching relays with 1 coil 30 mW. The P1 relay is available as through hole or surface mount type and capable to switch currents up to 1 A. Dielectric strength fulfills the requirements according FCC part 68 (1,5 kV – 10 / 160  $\mu$ s). Dimensions approx. 13 x 7,6 mm board space and 7 mm height for THT or 8 mm height for SMT version.

## W11 Relays

Low cost, non polarized 1 c/o relay for various applications. Nominal voltage range from 3 ... 24 V, coil power consumption 450 mW, sensitive versions 200 mW. The W11 relay is capable to switch currents up to 3 A. Dielectric strength 1000 Vrms. Dimensions approx. 15,6 x 10,6 mm board space and 11,5 mm height.

## Reed Relays

High sensitive, non polarized relay for telecom and various other applications, available with 1 n/o, 2 n/o or 1 c/o contacts. Nominal voltage range from 5 ... 24 V, coil power consumption 50...280 mW for 1 n/o and 125 ... 280 mW for 2 n/o or 1 c/o versions. Reedrelays are available in DIP or SIL housing and capable to switch currents up to 0,5 A. Integrated diode and/or electrostatic shield optional. Dielectric strength 1500 Vdc. Dimensions approx. 19,3 x 7 mm board space and 5 ... 7,5 mm height for DIP or 19,8 x 5 mm board space and 7,8 mm height for SIL version.

## Cradle Relays

Extremely reliable and mature relay family of 1<sup>st</sup> generation for various signal switching applications. Available as non polarized, polarized / latching and relay with AC coil. The benefit is the possibility of combining various contact sets from 1 up to 6 poles, single and bifurcated contacts, different contact materials with a coil voltage range from 1,5 Vdc to 220 Vac. Cradle relays are available as dust protected and hermetically sealed versions, with plug in or solder terminals and are capable to switch currents up to 5 A. Forcibly guided (linked) contact sets optional. Dielectric strength 500 Vrms. Dimensions from approx. 19 x 24 to 19x35 mm board space and 30 mm height.

## Other Relays

We offer a variety of different relay families for maintenance and replacement purposes. These relays are up to 60 years old now, such as Card Relay SN (V23030 / V23031 series), Small General Purpose Relay (V23006 series), Small Polarized Relay (V23063 ... V23067 and V23163 ... V23167 series). Accessories like sockets, hold down springs, etc. optional.

## HF3 Relay

High performance low cost RF relay with excellent RF characteristics. Available with an impedance of 50 and 75 Ohm. Suitable for frequencies up to 3 GHz. Actually smallest RF relay available combining small size, excellent RF performance and SMD solderability. Available as non latching or latching relay with 1 or 2 coils and a nominal coil voltage range from 3 ... 24 V, coil power consumption 140 mW, latching relays with 1 coil 70 mW. Dimensions 14,6 x 7,3 x 10 mm.



Tyco Electronics AXICOM Ltd.  
Seestrasse 295 - P.O. Box 220  
CH-8804 Au-Wädenswil / Switzerland  
Phone +41 1 782 9111  
Fax +41 1 782 9080  
E-mail: [axicom@tycoelectronics.com](mailto:axicom@tycoelectronics.com)



Tyco Electronics  
Paulsternstrasse 26  
D-13629 Berlin / Germany  
Phone +49 30 386 38573  
Fax +49 30 386 38575  
E-mail: [axicom@tycoelectronics.com](mailto:axicom@tycoelectronics.com)



Tyco Electronics EC Trutnov s.r.o.  
Komenského 821  
CZ-541 01 Trutnov / Czech Republic  
E-mail: [axicom@tycoelectronics.com](mailto:axicom@tycoelectronics.com)

Tyco Electronics Corporation  
POB 3608,  
Harrisburg, PA 17105, USA  
Phone +1 800-522-6752